

*To be specified:*

**Sensor Faucet**

- Discharge: On-demand; Up to 10 seconds while activated.
  - Single Supply - TEL3GGC-10
  - Thermal Mixing - TEL5GGC-10
- Discharge: On-demand; Up to 60 seconds while activated.
  - Single Supply - TEL3GGC-60
  - Thermal Mixing - TEL5GGC-60

**Optional Accessories:**

- 4" cc Cover Plate - TN71V100
- 8" cc Cover Plate - 71244T8CC

*Meets the American Disabilities Act Guidelines and ANSI A117.1 requirements for people with disabilities, and ANSI A112.18.1M as metering / self-closing faucets.*

**NOTE:**

*Following the Federal mandate for water efficiency outlined in the Environmental Protection Act of 1992, Electronic Faucets can be rated for water consumption based on two standards: flow rate and water consumption.*

*With the "Water Consumption" standard, a faucet must not use more than 0.25 gallons of water per cycle.*

*The TOTO faucets with a 10 second cycle uses 0.17 gallons of water.*

*This is a 32% below the base line of 0.25 gallons per cycle.*

*TOTO uses water consumption because it is the most accurate method of measuring water use. This method of measurement can be incorporated into water usage calculations for various efficiency programs. For more information, please consult [www.totousa.com](http://www.totousa.com)*

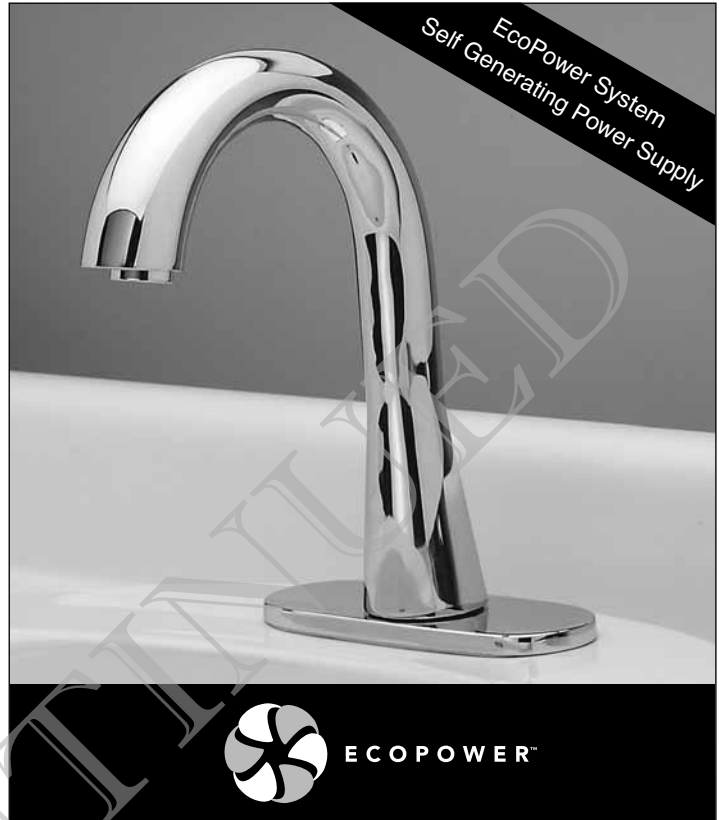

ECOPOWER™

TEL3GGC-10

### AUTOMATIC FAUCETS- ECOPOWER SYSTEM

Designed for new and retrofit installations, TOTO's new technology of EcoPower generation sensor faucets offer easy installation without the cost and downtime required to install power supplies and wiring for each faucet. A contemporary styled spout provides a cascading flow of water over the users' hands, utilizing less than 0.17 gallons per cycle, while a hydro-powered turbine charges the power supply during usage eliminating the need for battery replacement or consumption of external electrical power for up to 10 years.

### DURABLE AND SAFE

In today's facilities, durability and safety are essential. That's why TOTO faucets incorporate several integral features: an anti-scald thermal mixing chamber, waterproof electronic components, vandal proof assembly, a removable strainer to prevent clogging and make cleaning easier, and no touch operation. Mounting brackets with integral strainers and a self-cleaning solenoid valve allow for virtually uninterrupted use in high debris areas.

### THERMOSTATIC MIXER

Unlike a standard mixing tee, TOTO's true thermostatic mixing valve provides an anti-scald feature using a state of the art shape memory alloy (SMA) controller. This mechanism reacts instantaneously to water reaching excessively high temperatures and automatically turns the water off preventing any discharge. Temperature stability is maintained to within +/- 3° F regardless of pressure and temperature fluctuations in the supply lines. Check valves are integrated into the mixer to prevent cross flow of water. The temperature of the water can also be adjusted with an external control knob.

### "SMART SENSOR"

A self-adjusting sensor facilitates installation by preventing the need to make additional manual adjustments to the detection range, depending on the size of the basin the faucet is installed upon. The faucet will also automatically shut off in cases where false detection may occur, preventing water from continuously running.

### OPERATING PROCEDURE

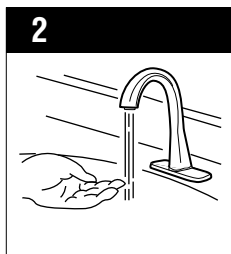
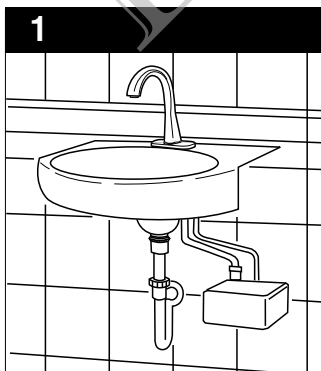

By placing your hands under the faucet, a sensor beam path is broken, causing the water to turn on.

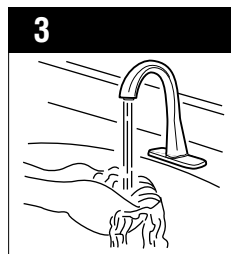

Water flows for as long as you need it while your hands are under the faucet.

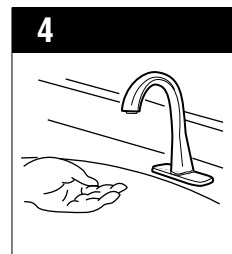



After pulling your hands away, the water turns off immediately, saving water.



# Self-Generating EcoPower System Sensor Faucet, Gooseneck Spout

## SPECIFICATIONS

<b>Product</b>	TEL3GGC-10 - Single Supply, Single Hole - Discharge: On-demand; Up to 10 seconds while activated. TEL5GGC-10 - Thermal Mixing, Single Hole - Discharge: On-demand; Up to 10 seconds while activated. TEL3GGC-60 - Single Supply, Single Hole - Discharge: On-demand; Up to 60 seconds while activated. TEL5GGC-60 - Thermal Mixing, Single Hole - Discharge: On-demand; Up to 60 seconds while activated. <i>Optional Parts: TN71V100 - 4" cc Cover Plate for 2002 Model; 71244T8CC - 8" cc Cover Plate</i>
<b>Power supply</b>	<b>Hydro-Power Charge.</b> 10 year based on 2,000 cycles per month <i>(Backup battery: 4 years at 4,000 cycles per month w/o recharging)</i>
<b>Hot/Cold-water supply</b>	Minimum required water pressure: 20PSI Maximum water pressure: 125PSI
<b>Water supply connection</b>	1/2" I.P.
<b>Water Consumption</b>	<b>10 Second Faucet: 0.17 gallons (max); 60 Second Faucet: 1.06 gallons (max)</b>
<b>Water saving function</b>	Automatically turns OFF when user removes hands. Maximum continuous run time is 10 or 60 seconds.
<b>Detection time</b>	ON feature: Immediate OFF feature: 1 second delay
<b>Detection range</b>	Factory set from 2 1/4". The faucet automatically sets the detection range according to the size of the basin.
<b>Discharge water temperature control range</b>	<u>Thermal Mixing Faucet:</u> Cold water - 104°F (Max) (When used under standard conditions)
<b>Anti-scald safety feature</b>	Provides the user protection against exposure to excessive water or outlet temperature (Thermal mixing faucet, only) fluctuation resulting from normal variation in inlet water pressure.
<b>Warranty</b>	Limited three (3) years warranty on all component parts. Details available upon request.
<b>Listings</b>	 City of Los Angeles 

U.S. Patent No. 4742583, 5758688, 6076550 U.S. Patent Pending No. PCT/JP01/04079, PCT/JP01/04068, 2002-269745, 2002-269746, 2002-264784

## SUGGESTED ENGINEERING SPECIFICATION:

TOTO Model # \_\_\_\_\_ Automatic infrared sensor activated gooseneck spout faucet. Anti-scald, thermal mixing chamber (thermal faucets only). Automatic sensor adjustment on installation. Maximum discharge 0.17 gallons per 10 second cycle. Electrical components separated from spout assembly and

sealed in waterproof compartments. Single hole faucet with optional 4" cc and 8" cc cover plates. Through the use of TOTO's EcoPower system, using the faucet 11 times a day for 5 seconds or more will fully recharge the faucet.

## DIAGRAM:

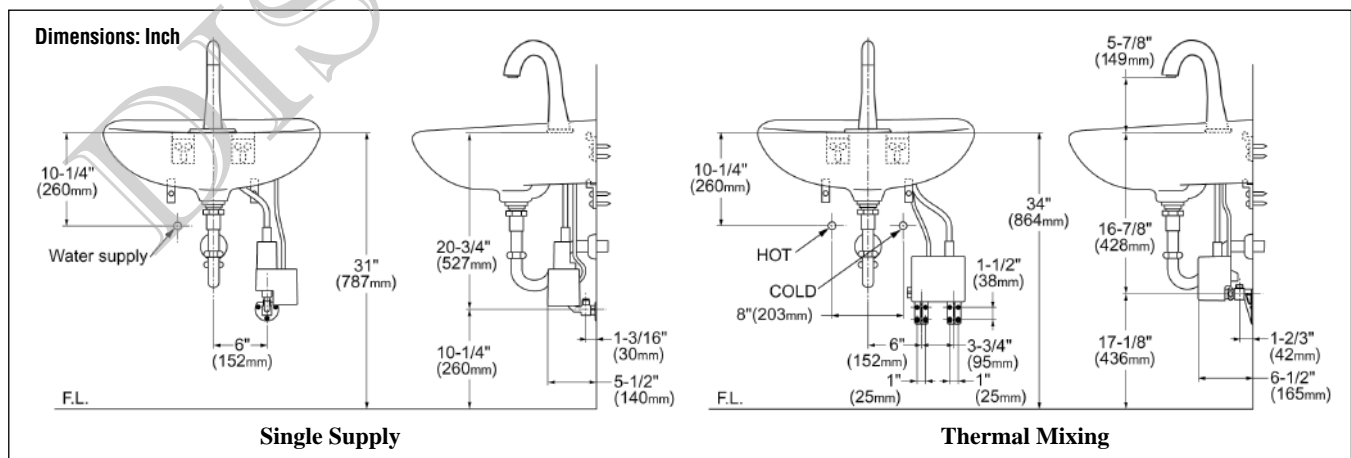

**TOTO®**

TOTO U.S.A., INC. • 1155 Southern Road, Morrow, GA 30260  
Tel. (888) 295-8134 • Fax. (770) 282-8701 • www.totousa.com

Printed in U.S.A. © TOTO LTD. 12/04 #J90080

Printed on recycled paper 

REV 02/09