

To be specified:

Sensor Faucet

- Continuous Discharge: Up to 10 secs.
 - Single Supply - TEL3DAC-10
 - Thermal Mixing - TEL5DAC-10
- Continuous Discharge: Up to 60 secs.
 - Single Supply - TEL3DAC-60
 - Thermal Mixing - TEL5DAC-60

Optional Accessories:

- 4" cc Cover Plate - TN71V1
- 8" cc Cover Plate - 71244T8CC
- Supply Tube(s) _____

Meets the American Disabilities Act Guidelines and ANSI A117.1 requirements for people with disabilities, and ANSI A112.18.1M as metering / self-closing faucets.

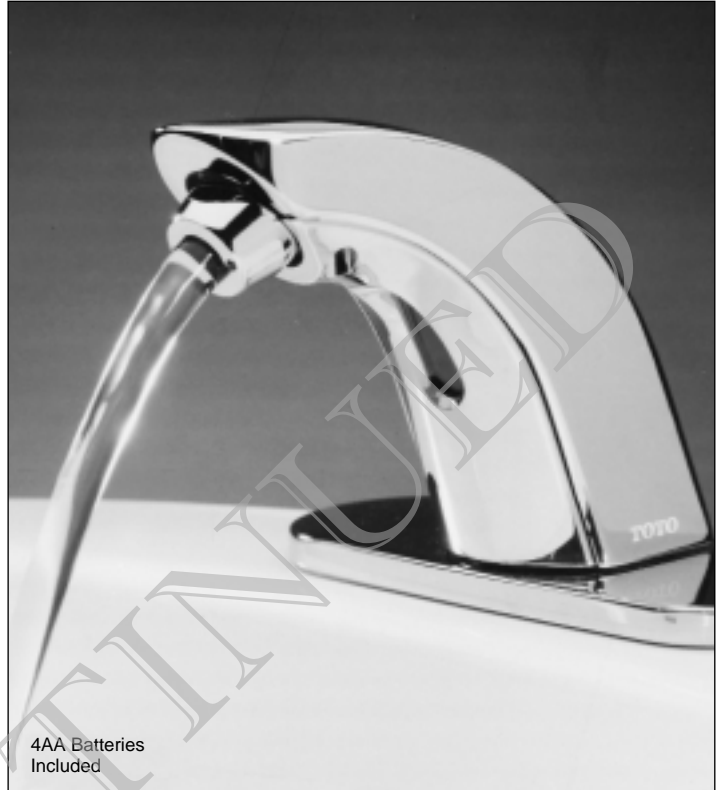

TEL3DAC-10
TEL5DAC-10

AUTOMATIC FAUCETS

Designed for new and retrofit installations, TOTO's battery powered automatic faucets offer easy installation, without the cost and downtime required to install power supplies and wiring for each faucet. A contemporary styled spout provides a cascading flow of water over the users' hands, utilizing less than 0.25 gallons per cycle.

DURABLE AND SAFE

In today's facilities, durability and safety are essential. That's why TOTO faucets incorporate several integral features: an anti-scald thermal mixing chamber, waterproof electronic components, vandal proof assembly, strainer to prevent clogging and make cleaning easier, and a no touch operation.

"SMART SENSOR"

A self-adjusting sensor eliminates installation and cycling hassles. TOTO "smart sensor" technology automatically sets the detection range according to environment conditions, preventing water from being discharged due to false detection.

OPERATING PROCEDURE

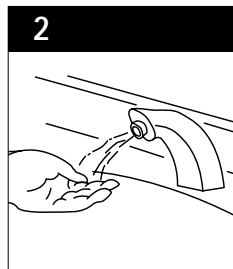
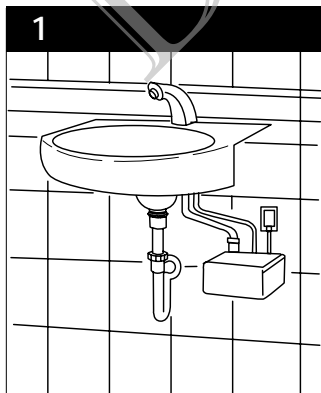

By placing your hands under the faucet, a sensor beam path is broken, causing the water to turn on.

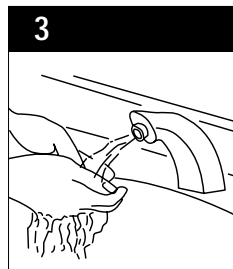

Water flows for as long as you need it while your hands are under the faucet.

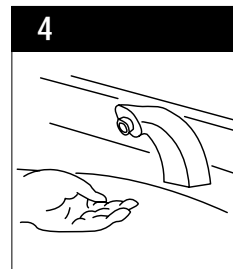



After pulling your hands away, the water turns off immediately, saving water.



Battery Powered(6V,DC) Sensor Faucet, Standard Spout

SPECIFICATIONS

| | |
|---|--|
| Product | TEL3DAC-10 - Single Supply, Single Hole - Continuous Discharge Up to 10 Seconds TEL5DAC-10 - Thermal Mixing, Single Hole - Continuous Discharge Up to 10 Seconds TEL3DAC-60 - Single Supply, Single Hole - Continuous Discharge Up to 60 Seconds TEL5DAC-60 - Thermal Mixing, Single Hole - Continuous Discharge Up to 60 Seconds <i>Optional Parts: TN71VI - 4" cc Cover Plate; 71244T8CC - 8" cc Cover Plate</i> |
| Power supply | Four AA alkaline batteries, included. 2 year life, based on 4000 cycles per month |
| Hot/Cold-water supply | Minimum required water pressure: 20PSI Maximum water pressure: 125PSI |
| Water supply connection | 1/2" I.P. |
| Flow rate | Max. 1.3 gpm, 0.25 gal/cycle |
| Ambient temperature | 32° - 131°F (0° - 40°C) |
| Water saving function | Automatically turns OFF after 10 seconds of continuous use |
| Detection time | ON feature: Immediate OFF feature: 1 second delay |
| Detection range | Factory set from 3.9" - 7.8". The faucet automatically sets the detection range according to the basin installed upon. |
| Discharge water temperature control range | <u>Thermal Mixing Faucet:</u> Cold water - 122°F (Max) (When used under standard conditions) |
| Anti-scald safety feature (Thermal mixing faucet, only) | Provides the user protection against exposure to excessive water or outlet temperature fluctuation resulting from normal variation in inlet water pressure. |
| Warranty | Limited one (1) year warranty on all component parts. Details available upon request. |
| Listings |  City of Los Angeles  |

U.S. Patent No. Design 361826
5063622
4742583

SUGGESTED ENGINEERING SPECIFICATION:

TOTO Model # _____ Automatic infrared sensor activated faucet. Anti-scald, thermal mixing chamber (*thermal faucets only*). Automatic sensor adjustment on installation. Four AA alkaline batteries with a two year life at 4,000 cycles per month, included. Maximum discharge 1.3 gallons per minute

(0.25 gal./cycle), and ten seconds per cycle. Electrical components separated from spout assembly and sealed in waterproof compartments. Single hole faucet with optional 4" cc cover plate. Vandal resistant, non-aerator brass nozzle.

DIAGRAM:

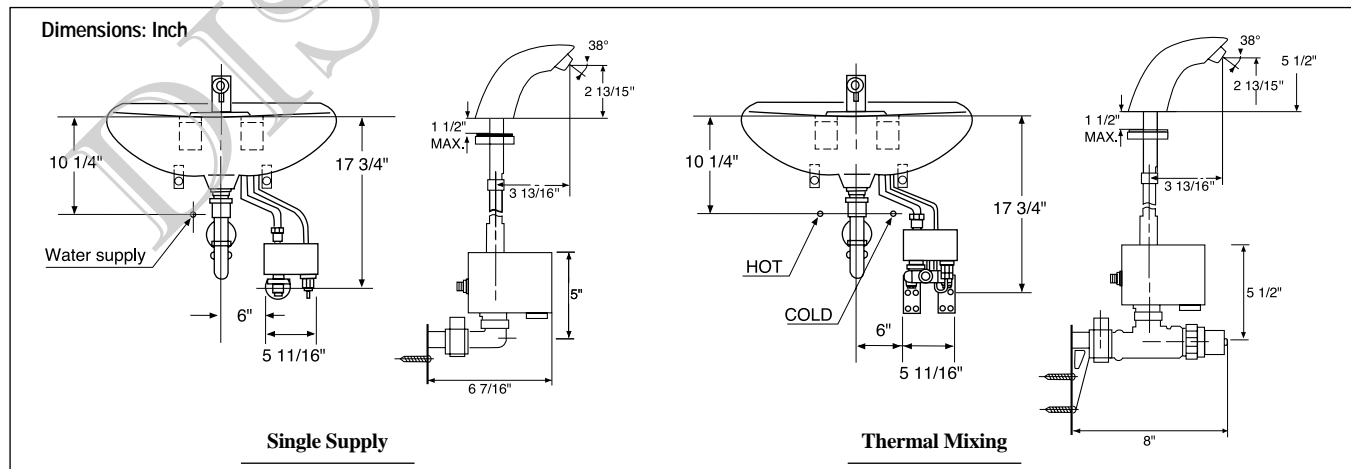

TOTO[®]
Perfection by Design

TOTO U.S.A., INC. • 1155 Southern Road, Morrow, GA 30260
Tel. (770) 282-8686 • Fax. (770) 282-8701 • www.totousa.com
Printed in U.S.A. © TOTO LTD. 8/00

Printed on recycled paper 

REV 4/00